

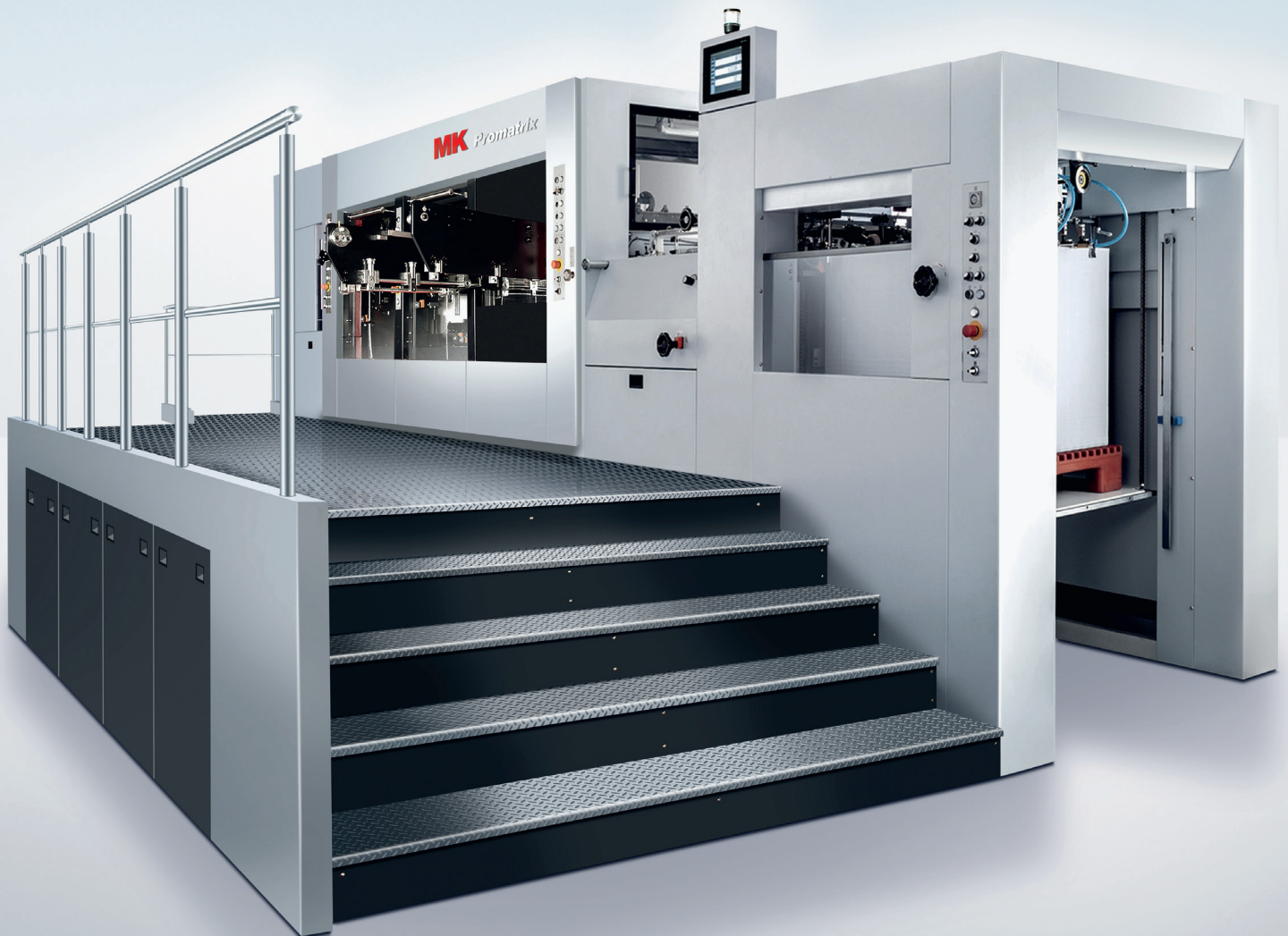

Blanking Makes the Difference. **Promatrix 106 CS/CSB.**



The Easy Access to Folding Carton Production.

Promatrix 106 CS/CSB.

Whether it's for production of folding carton boxes, labels or display. Cutting, creasing, embossing, scoring or perforating. Whether it's for short job runs where only the waste needs to be broken out or long job runs where a complete separation of the job can reduce the cost of production. The Promatrix 106 offers the right die-cutting solution for all your applications at the right price to ensure you get a reliable return on your investment.

The Promatrix 106 is available in two versions: On the one hand as die-cutting machine with stripping function – Promatrix 106 CS. And on the other hand as die-cutting machine with stripping station and blanking function – Promatrix 106 CSB. The Promatrix 106 is distinguished not just by its high performance but also by easy operation and short change-over times.

The Promatrix 106 CS was launched at first and has met the expectations of medium-sized and industrial packaging printers.

Followed by the Promatrix 106 CSB in 2016. The machine is based on the established technology of the 106 CS and is extended by a blanking station and some additional benefits. The Promatrix 106 CSB suits companies looking to reduce their manufacturing costs and shorten production time by eliminating manual operations as well as established packaging printers already producing on an industrial scale who need to increase capacity or replace obsolete equipment.

The machine can handle an impressive range of materials and this offers a lot of different application and job opportunities to meet your customers demanding expectations. The Promatrix 106 is able to handle e.g. labels and thin paper banderoles as light as 90 g/m². Typical folding carton boxes as e.g. for food, cosmetics, confectionery, pharmaceuticals and health care up to 2,000 g/m² can be cut and stripped at the Promatrix and even blanked on the CSB version. Running corrugated products with a max thickness of 4 mm is not a challenge for the machine allowing you to add high value added products such as promotional display to your production range.

The Promatrix 106 can optionally be equipped with the MasterSet optical alignment system. This system allows printed sheets to be aligned precisely by using print marks, the sheet edge or a reference in the print image, before they are fed into the die-cutting station. This ensures high quality and high register accuracy of your products.

The Promatrix 106 CS and CSB are manufactured by Masterwork and exclusively distributed and backed up by the professional and renowned worldwide sales- and service network of Heidelberg.

➔ [heidelberg.com/die-cutting](https://www.heidelberg.com/die-cutting)

Decisive Characteristics. The Facts at a Glance.



Highlights:

- Non-Stop function at feeder and delivery
- MasterSet – precise optical sheet alignment system (option)
- Pneumatic locking device for tools in cutting station
- Chase changer to prepare die-cutting tools outside of the machine (option)
- Integrated Quick lock system for stripping and blanking station
- Integrated fine adjustment system for thin cutting plates
- Sample sheet removal during production (CSB version only)

- Full automatic pallet change system at delivery (CSB version only)
- The basic machine is already equipped with all functions and equipment to start the production
- Short set-up times
- Easy operation concept
- Outstanding price-performance ratio

➔ heidelberg.com/die-cutting



长荣股份
MASTERWORK

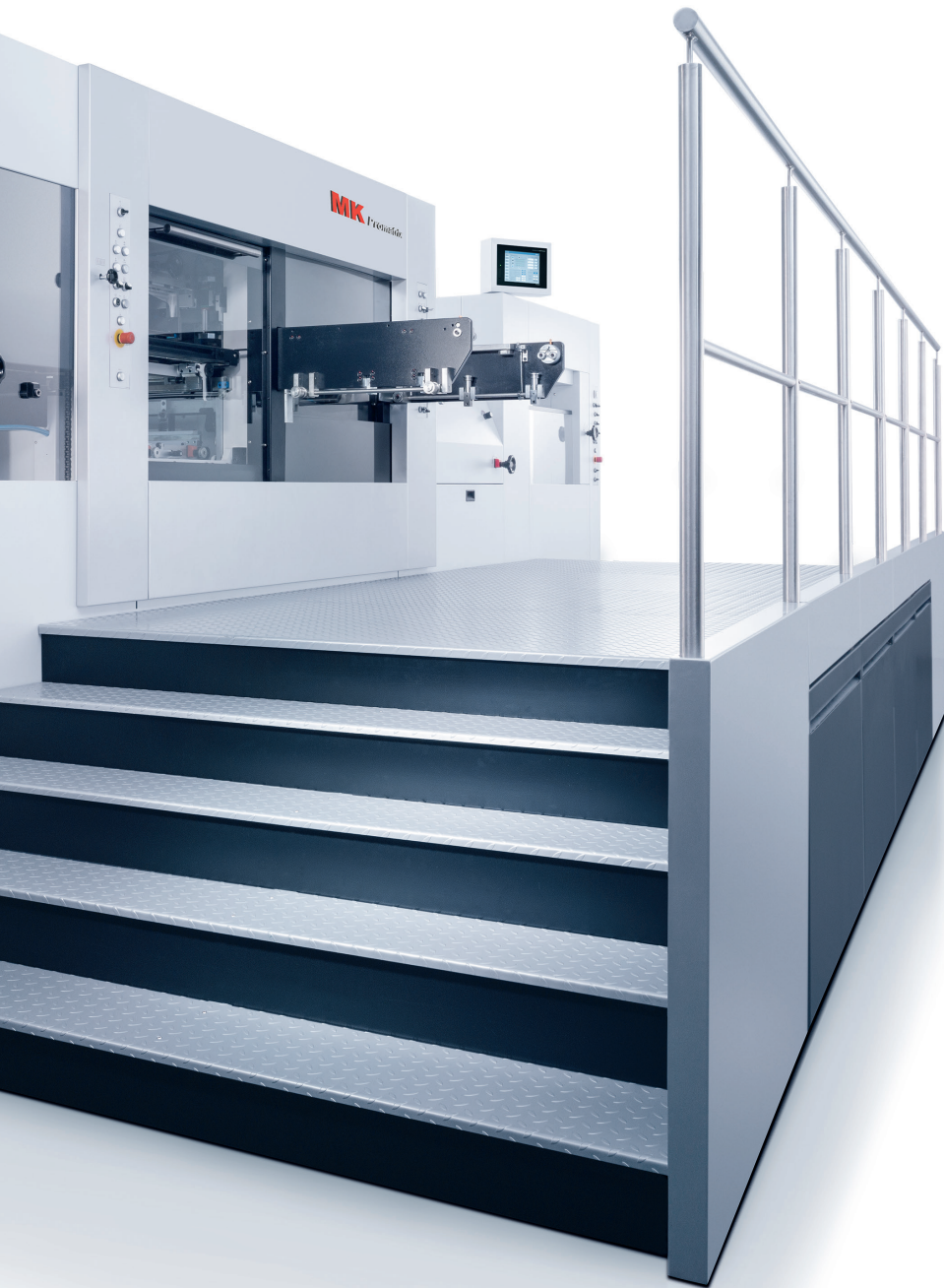

For value retention and maximum performance:

Service Agreements

- Service agreements offer security and peace of mind, while at the same time providing you with the benefits of full cost control and simple administration
 - Servicing by highly trained technicians
 - Exclusive use of original service parts
 - Protection of your machine investment
 - Retention of a high resale value
-

→ heidelberg.com/service-agreements

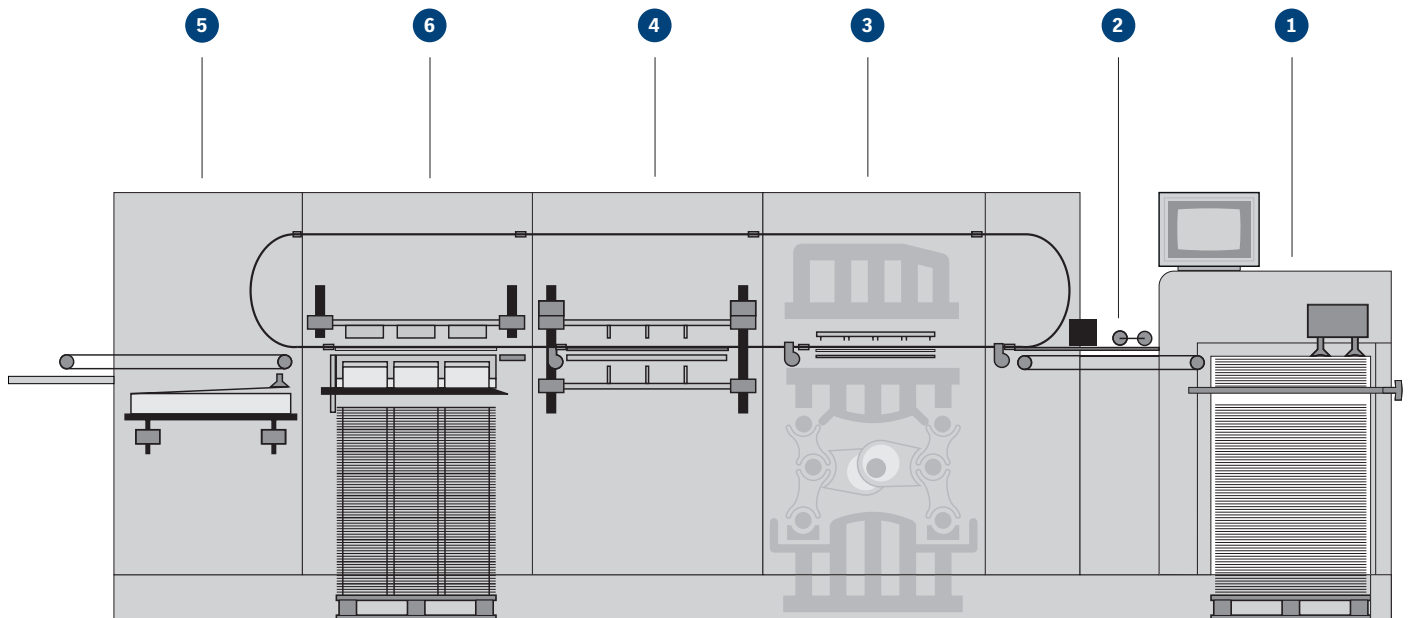

The machine shown is a sample configuration. Some of the equipment features mentioned are optional.

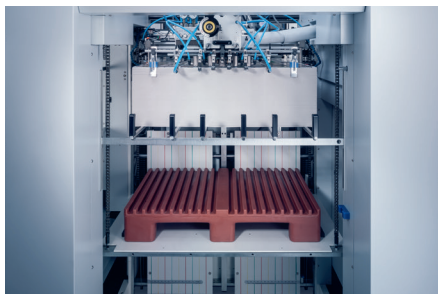

1 Non-stop Feeder

- Suction head for paper, board and corrugated board
- Motorized suction head adjustment (vertical and horizontal)
- Pile platform with motorized side pile adjustment
- Mechanical double-sheet detection

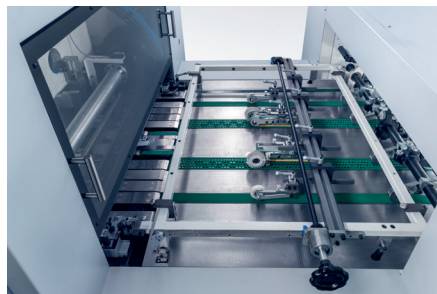

2 Feed Table

- Register system
- Pull/Push side lay on both sides
- Suction belt table
- Central adjustment system for rollers and brushes
- MasterSet – optical sheet alignment system
- Gripper opening for misaligned sheets
- Ultrasonic double-sheet detector

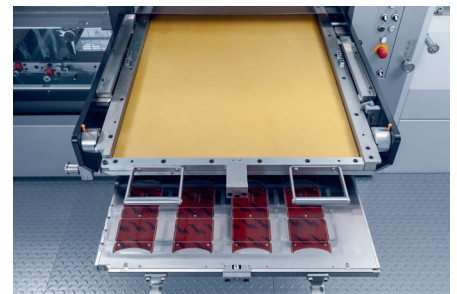

3 Cutting Station

- Register system
- Motorized cutting pressure adjustment
- Pneumatic locking device for die-cutting chase and cutting plate
- Cutting plate fine adjustment
- Air cushion for easy cutting plate handling
- Quick lock chase
- Chase changer (option)

Technical Data

Material	Promatrix 106 CS	Promatrix 106 CSB
Paper (min.)	90 g/m ²	90 g/m ²
Carton Board (max.)	2,000 g/m ²	2,000 g/m ²
Corrugated Board (max.)/with MasterSet	4.0 mm/2.0 mm (0.16 in/0.08 in)	4.0 mm/2.0 mm (0.16 in/0.08 in)
Performance Data		
Sheet Size (max.)	760 × 1,060 mm (29.92 in × 41.73 in)	760 × 1,060 mm (29.92 × 41.73 in)
Sheet Size (min.)/with MasterSet	300 × 350 mm/350 × 400 mm (11.81 × 13.78 in/13.78 × 15.75 in)	300 × 350 mm/350 × 400 mm (11.81 × 13.78 in/13.78 × 15.75 in)
Cutting Pressure (max.)	2.6 MN/260 t	2.6 MN/260 t
Machine Speed (max.)	8,000 sheets per hour	7,500 sheets per hour
Pile Height (incl. pallet)		
Feeder pile height (max.): w/o non-stop in non-stop operation	1,500 mm (59.06 in) 1,200 mm (47.24 in)	1,500 mm (59.06 in) 1,200 mm (47.24 in)
Feeder Pile Weight (max.)	1,500 kg	1,500 kg
Delivery pile height (max.)	1,400 mm (55.12 in)	1,400 mm (55.12 in)
Delivery Pile Weight (max.)	1,350 kg	1,350 kg



4 Stripping Station

- Register system
- Integrated quick lock systems for all tools (top, middle, bottom)
- Fine adjustment of tools with position indicators
- Test sheet removal
- Electronic sheet monitoring
- Pre-make-ready table (option)

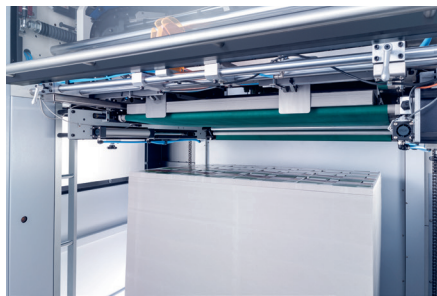

5 Delivery (only CS)

- Non-Stop rolling carpet
- Pneumatic flap for test sheet removal
- Sheet size adjustment with position indicators
- Sheet brake brush with motorized brake force adjustment
- Tape inserter (option)
- Gripper edge removal system (option)

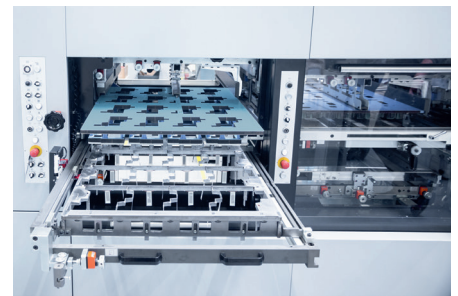

6 Blanking Station (only CSB)

- Auto-Non-Stop function
- Full automatic pallet change system
- Sample sheet removal system (during production)
- Integrated quick lock system for top tooling
- Fine adjustment of top and bottom tools with position indicators
- Tie sheet cassette
- Vacuum bar
- Blanking- or full sheet operation

Features and Benefits.

Promatrix 106 CS/CSB.

Availability

The perfect solution for **Advanced Commercial Applications** and folding carton production.

Format: 760 × 1060 mm.
Compatible with all Heidelberg 70 × 100 Speedmaster presses, including the **Speedmaster XL 106.**

CS or CSB.

Available with cutting, stripping and blanking* (*only in CSB).

Productivity



Cutting Speed.

CS	CSB
8,000 sph	7,500 sph

with non-stop operation in feeder and delivery.

Processes board up to

2,000 g/m².

Cutting versatility.

Processes materials as thin as **90 g/m².**

User Friendliness

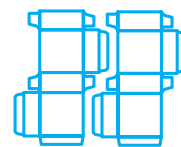

Motorised

cutting pressure adjustment. **Quick Lock** systems for the tools in the cutting, stripping and blanking station are included in the machine standard.



Safe Operation.

Confirmed by GS approval.

Easy to learn, simple to use – thanks to touchscreen user interface.

Sales and Service Partner:
Heidelberger Druckmaschinen AG
Kurfuersten-Anlage 52 – 60
69115 Heidelberg
Germany
Phone +49 6221 92-00
Fax +49 6221 92-6999
heidelberg.com



Publishing Information

Printed in: 12/20
Photographs: Heidelberger Druckmaschinen AG
Platemaking: Suprasetter
Printing: Speedmaster
Finishing: Stahlfolder
Consumables: Saphira
Fonts: Heidelberg Antiqua ML, Heidelberg Gothic ML

Printed in Germany

Trademarks

Heidelberg, the Heidelberg logotype are registered trademarks of Heidelberger Druckmaschinen AG in the U.S. and other countries. All other trademarks are property of their respective owners.

For details on the emissions of the Diana Promatrix 106 CS/CSB, please visit us at heidelberg.com/emissiondetails

Subject to technical modifications and other changes.

Liability for contents

The contents of this brochure have been prepared with great care. No warranty or liability is accepted for the correctness, completeness, or accuracy of the information. There is no guarantee that the customer will be able to achieve the values and numbers (e.g. relating to the function and performance of the machine and the software) specified in the brochure. The information provided is based on ideal conditions and proper use of the machine and the software. Achieving these values and numbers depends on a variety of factors and circumstances that are outside the control of Heidelberg (e.g. machine settings, technical conditions, ambient conditions, raw materials and supplies used, consumables used, standard of care and maintenance of the machine, expertise of the operator, meeting the respective system requirements, etc.). They therefore constitute neither characteristics of the machine or the software nor a guarantee. This brochure does not constitute a contractual offer and is solely for the purpose of providing (non-binding) information.



business partner of
HEIDELBERG

