

Digital freedom.  
**Versafire LP.**





# All-round productive. More than digital printing.

## **Versafire LP from HEIDELBERG – your reliable partner in the production mix.**

Meeting the current market trends and customer requirements with our new, highly productive, digital printing press for small and large print runs in the commercial sector. The powerful Versafire LP stands for the best quality, large print volumes and a wide variety of materials.

As a digital all-rounder, Versafire® LP with automatic color measurement and inline register ensures more safety and efficiency in your production. Output switching between offset and digital printing, including color adjustments, can be done in seconds, even at the last minute. You can respond to customer needs at any time.

Benefit from the numerous advantages of digitalization: In the pressroom, it simplifies the control and operation of the machines. On a commercial level, it offers insights into the productivity of the digital printing press at all times.

When you choose HEIDELBERG®, you buy more than just a digital printing press. You get access to an ecosystem that offers real added value – with service, consumables, digital services, software, cloud-based solutions, training and advice. We accompany you into the future.

 [heidelberg.com](https://www.heidelberg.com)

# Designed for perfection. **Versafire LP.**

**Versafire LP sets standards in terms of productivity and quality. It is ideal for different pressruns and for variable data printing.**

Experience maximum diversity – in everyday production as well as in machine equipment. The modular Versafire LP can be converted at any time in terms of speed and the desired feeders and finishers on site to meet changing requirements.

Designed for wow effects. Inside the Versafire LP, an active perfecting register scanner in conjunction with continuous calibration and integrated sheet cooling ensure reproducible quality. Optionally, each individual sheet can be compared with the corrugated PDF data and automatically rejected if there are any deviations. The result: always a perfect pile

Integrated postpress opens up new possibilities, including on-demand production in print run one. A sorted output of jobs saves time in finishing and reduces delivery times. With Versafire LP, you expand your offering. If requested, brochures trimmed on three sides with a straight spine, posters up to 1,260 millimeters long, and six- or eight-page banners including duplex creasing can be produced.

Productivity begins with the intuitive operation of the Versafire LP. You can set up new media quickly and easily on the 21.5-inch touch-screen monitor. For direct help with questions, online help and special videos are available around the clock, supplemented by training on site or in our international training centers. For best performance from day one.

 [heidelberg.com/en/versafire-lp](https://heidelberg.com/en/versafire-lp)





Z  
O  
E  
A  
R  
E  
P  
O

# Simply different.

## Prinect Digital Frontend.

**Intelligent automation makes working easy and intuitive. That's why we developed the Prinect Digital Frontend for the Versafire – as a smart control center for short production times, quick job changes and personalization.**

### **Easy, fast and cost-effective.**

The Prinect® Digital Frontend supports the standardized Production without compromise. Whether order creation, preflight check, color management or imposition, all steps can be automated.



**Prinect**

## **Transparent production – developed for the graphic industry.**

### **Automation**

#### **It's that easy**

The Prinect Digital Frontend simplifies your prepress tasks through highly automated, smart production. Prepress sequences reduce touchpoints as well as time and costs per job.

### **Ease of use**

#### **See what's coming (WYSIWYG)**

The clear user interface, including a live preview of the print job, makes job preparation intuitive and quick. In conjunction with functions such as standardized sequences, time savings in prepress are possible.

### **Color management**

#### **Knowing how**

The know-how of HEIDELBERG in creating media-specific profiles and color management forms the basis for impressive printing results. In addition, the Prinect DFE offers you the easy option of adjusting and simulating special colors.

### **Integration**

#### **Independently or in offset workflow**

The Prinect Digital Frontend can be operated independently or integrated into the Prinect Production Workflow. This means you can produce jobs either digitally or in offset from a workflow.

Use the advantages of digital integration at HEIDELBERG – maximum flexibility, output security, and fast processing under a common user interface.

→ [heidelberg.com/en/prinect-digital-frontend](https://heidelberg.com/en/prinect-digital-frontend)



C  
N  
N  
A  
R  
T

*Black Lilies*

*Black Lilies*

*Black Lilies*



# Knowing how. Versafire Production Training.

**Expertise is the key to reliable production. Our Versafire Production Training explains media setup and practical handling during production. So that working with Versafire LP is always a breeze.**

**Quickly and safely. The media database for the best results.**

A standard media library is built into every Versafire. However, there are thousands of printing materials that you can print jobs on. The Versafire Production Training (Professional Level) explains how to optimally set machine parameters for different materials.



## **It's so easy to become an application and media professional:**

### **Overcoming challenges**

#### **Professional-level training**

Our professional-level training shows you how to make optimal use of the Versafire's capabilities. It is aimed directly at the operators and is ideally carried out after the first four to twelve weeks of experience with the Versafire.

Learn on-site from our experienced experts how to adjust media to maximize print quality. Benefit from many tips and tricks that will make your daily work easier.

### **Suitable for your needs**

#### **Individual media management**

The right media setup simplifies the production challenges. It's easy with the Versafire's wizard-driven user interface, which drastically reduces the time and effort required for media setup. All settings can be saved, exported, imported and assigned to a paper tray so that no media settings are lost. In the event of a malfunction, our experts will check the submitted settings.

# VERSAFIRE L

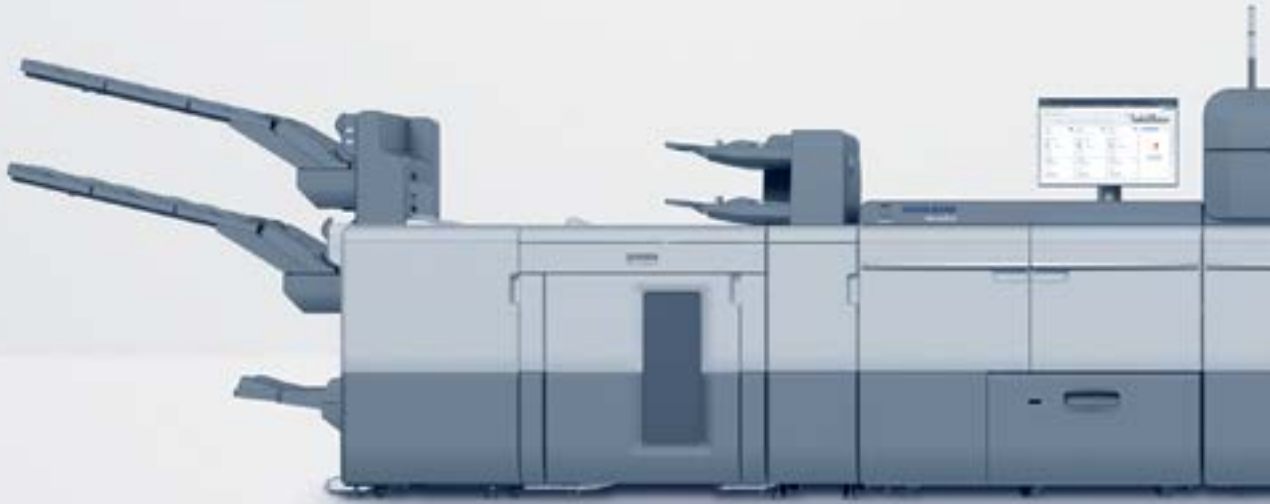

**Banner printing** up to 1,260 mm printed on one side or 1,030 mm printed on both sides. Suitable for the production of six to eight-pagers as well as large posters on one sheet.



**Quality proof** using automatic inline PDF-based color matching and correction as well as defect detection provides security and reduces manual effort.



**Intuitive color management** with media-specific ICC profile creation ensures easy color adjustment to offset.

# P

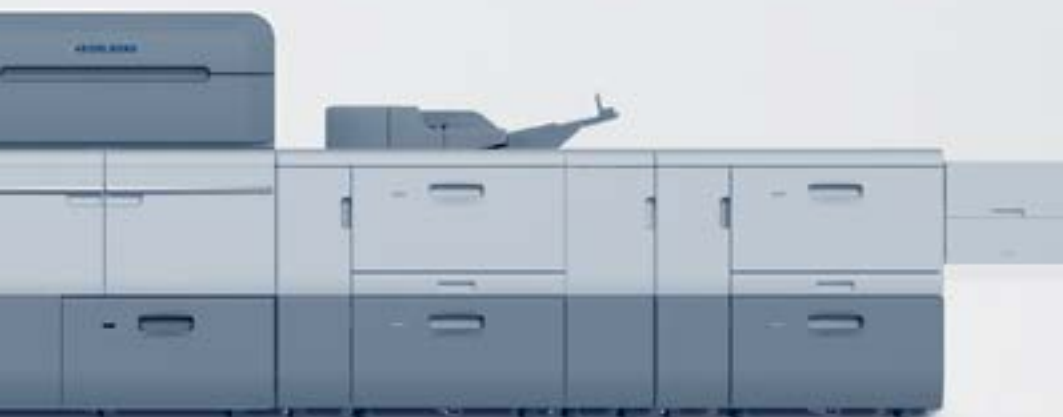

**Twin Toner Bay** with two cartridges per color allows toner replacement in non-stop operation for consistently high productivity.



**Interposer** introduces pre-produced sheets into the pile during ongoing print production – for seamless inline postpress.



Two large **vacuum feed trays (Vacuum Feed LCT)** with optimized sheet control for lateral stabilization of the pile during feeding.

# 8

## Inline finishing

**High added value**, because printing and postpress take place in one go.

**Continuous production** with new postpress options increases the diversity of the offering and shortens production and delivery times.

# 6

## New basic computer

**Intuitive operation** on the 21.5" touchscreen monitor with browser-based user interface and media recognition unit.

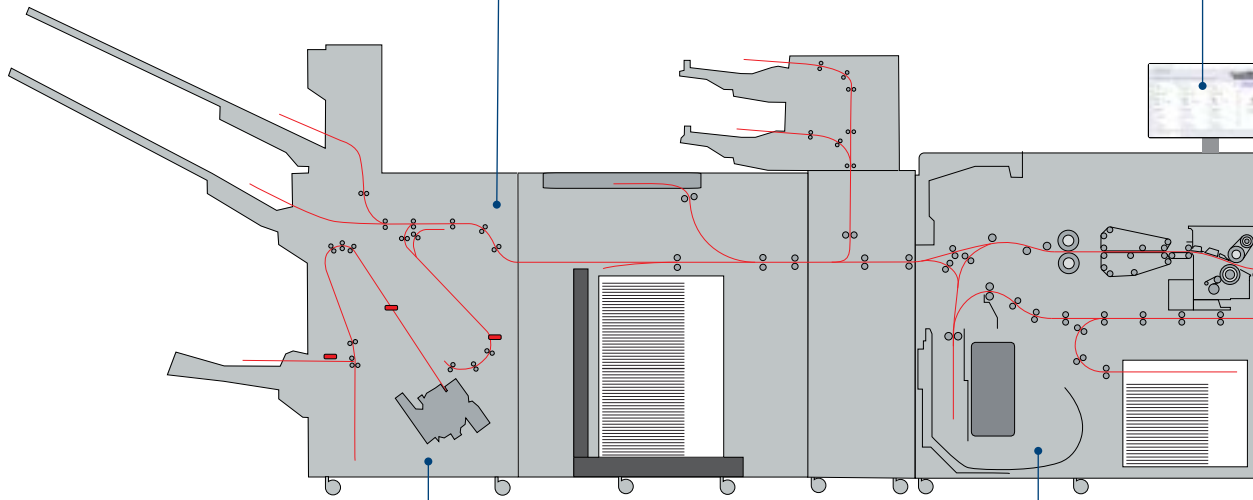

# 9

## Supported paper transport

**Reliable processing** of grammages from 40 to 470 g/m<sup>2</sup> thanks to the large transport radius.

# 7

## Integrated Quality Proof

**Automatic quality control** in the ACD (Auto Color Diagnosis) unit.

Color deviations are automatically detected and corrected through real-time measurement of each individual sheet after printing in the **Image Quality Monitor**.

Defects such as artifacts on the sheet can be detected by **comparison with the PDF data** and the sheets can be rejected if necessary.

# 4

## High quality CMYK printing

With **two toner cartridges per color** in the **twin toner bay**, non-stop production can be carried out in CMYK.

This enables cartridges to be changed during operation, an essential requirement for autonomous production.

# 2

## Large feed station trays

Sufficient space for the **printing material**, suitable for, e.g., 2,500 sheets each at 80 g/m<sup>2</sup> grammage.

They can be refilled independently during production and increase the **production capacity** during autonomous production.

# 1

## Separate banner trays

Additional material trays provide **space for large formats** such as banners up to 960 mm long.

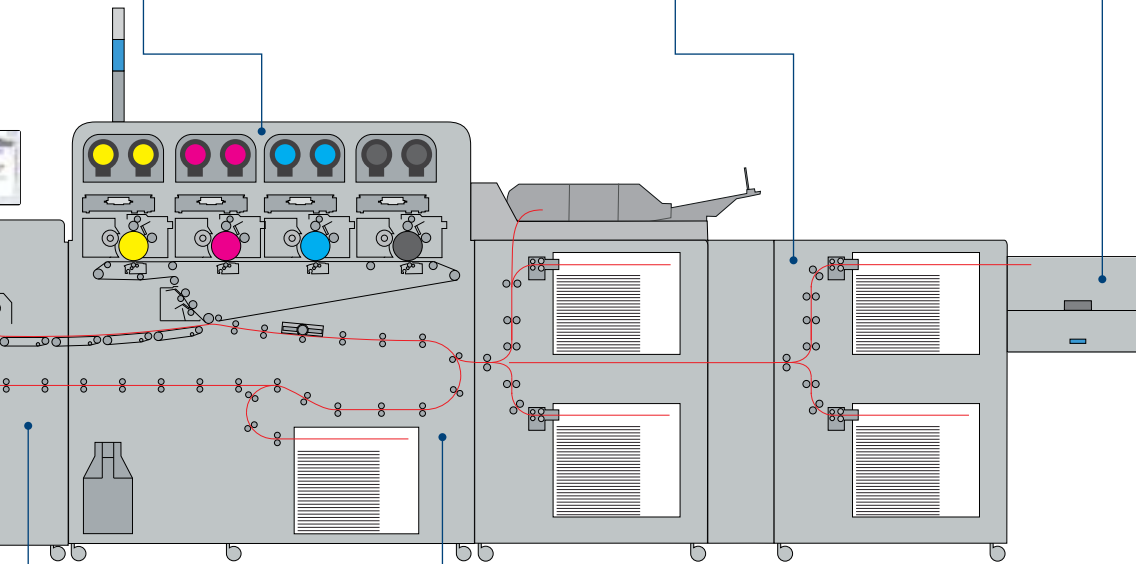

# 5

## Fuser Technology

**The fuser** fixes the applied toner onto the sheet at up to 200 °C, depending on the material thickness.

Depending on the motif, **the gloss level** can be adjusted individually.

# 3

## Automatic alignment

The paper alignment is essential for accurate, **high-quality perfecting**.

The **Swing and Shift technology** ensures this register accuracy right up to the banner format.

In the feeding tray, **sensors and air support** prevent the infeed of double sheets.

**Vacuum suctiontapes** ensure safe processing of a **wide variety of printing materials**.



Further information and technical details about the Versafire LP can be found here:

➔ [heidelberg.com/en/versafire-lp](https://heidelberg.com/en/versafire-lp)

# Simply perfectly prepared. Prinect PDF Toolbox.

The Prinect PDF Toolbox significantly simplifies your daily work with PDFs from a wide variety of sources. Optimize your production process with a variety of powerful tools to edit PDF files effortlessly.

## PDF Assistant PLUS Suite

A kit with extensive tools, tailored to the specific requirements of digital printing.

## PDF Assistant

Powerful tools for checking and correcting PDF documents for error-free print production with preflight, PDF VT control, page assembly, definition of page geometry and register as well as PDF comparison function.

## Coating Editor

Automatic creation of special color layers in PDF documents.

## Object Editor

Display and processing of objects or objects parameters in PDF documents.

## Document Assembly

Offline compilation of PDFs into complete jobs including media and register adjustments.

## Page Assembly & Barcode & VDP Editor

Creation of variable identification and production barcodes (EAC/UPC/Data Matrix) directly in the PDF document as well as creation of simple variable PDF/VT documents.

➔ [heidelberg.com/en/prinect-pdf-toolbox](https://heidelberg.com/en/prinect-pdf-toolbox)



**PDF/VT creation**  
Professional tool for personalized content



**Color management**  
Cross-media help with color check and optimization



**PDF boxes and sizes**  
Security during the assembly and output of PDF print sheets

“

It is incredibly convenient to be able to respond so easily and quickly to our customers' needs. Because thanks to Versafire, we can afford to deliver a few copies in a short time at reasonable prices.

**Riccardo Gianetti**  
Managing Director  
GIDA S.R.L.  
Italy



Discover what our customers say.

→ [heidelberg.com/  
medialibrary](https://heidelberg.com/medialibrary)

# Everything you need in one place. The HEIDELBERG ecosystem.

## Remote Services

Enjoy the benefits of fast and remote problem solving, maintenance and analysis of machine performance.



## On-site services

From technical service to parts delivery: To ensure stability in your production, we provide 24/7 support worldwide.



## Prinect Business

Automate your commercial processes and see where you make or lose money.

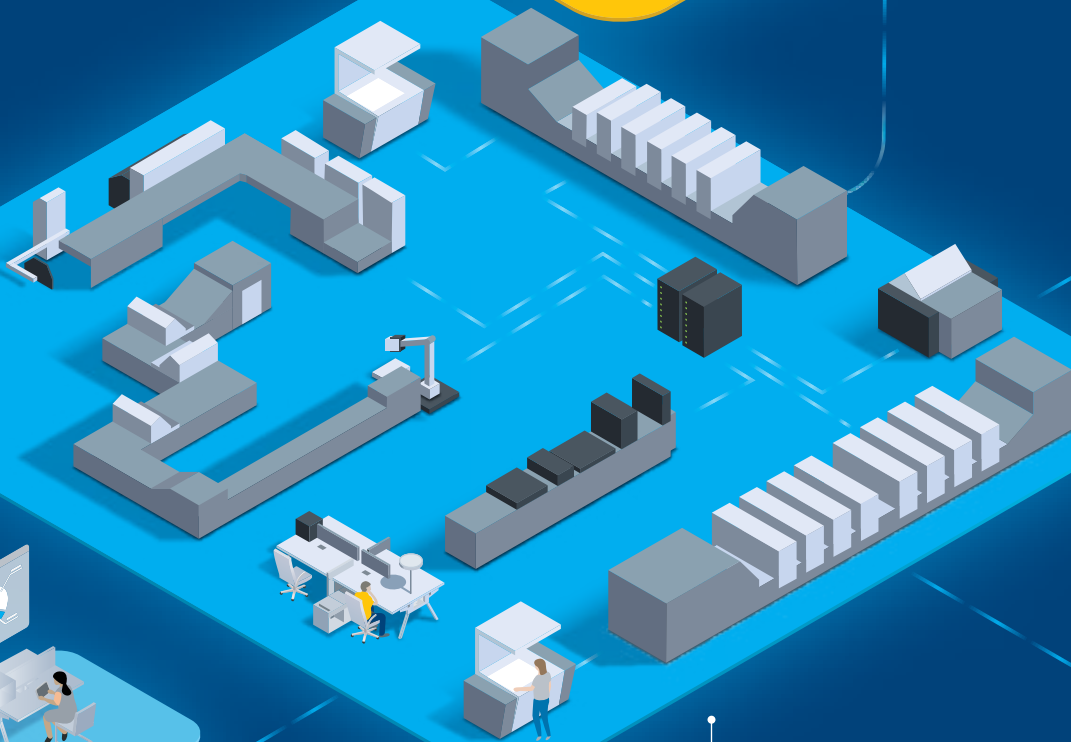

## Prinect Production

Make your print processes perfectly seamless with volume-based pricing.

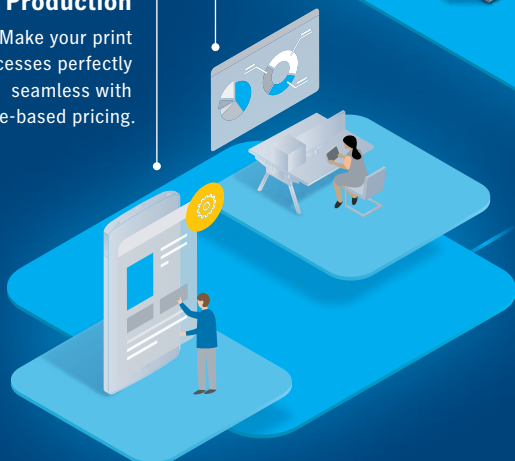

## End-to-end production workflow

Increase productivity with speed, quality, digital integration, and reliability.



Every print shop is different, and every customer has unique, comprehensive needs. That is why we have developed our offerings to serve these needs all across the spectrum. What makes us

unique is that you can find everything here that makes your print shop smarter, faster, and better. Make HEIDELBERG your one-stop shop for everything that contributes to your success.



### The digital customer portal

Reach cloud-based production, shopping, support, reporting, and administration services from anywhere, at anytime.



### Sustainable production

Go green and reduce waste and energy consumption with our sustainable solutions.



### Saphira® Consumables

Use proven and tested consumables optimized for your HEIDELBERG equipment, including an eco-friendly product line.



### The right investment

HEIDELBERG machines have a high resale value. If you invest in it today, it will pay off in the future.



### Print Media Center Network

Experience our equipment running at three locations: Wiesloch-Walldorf (GER), Atlanta (USA), Shanghai (CHN)

# HEIDELBERG Contracts.

## Contract packages as individual as your requirements.

You benefit from a combination of best-in-class products from HEIDELBERG. Our Lifecycle and Subscription packages help you keep your machines running at their best.

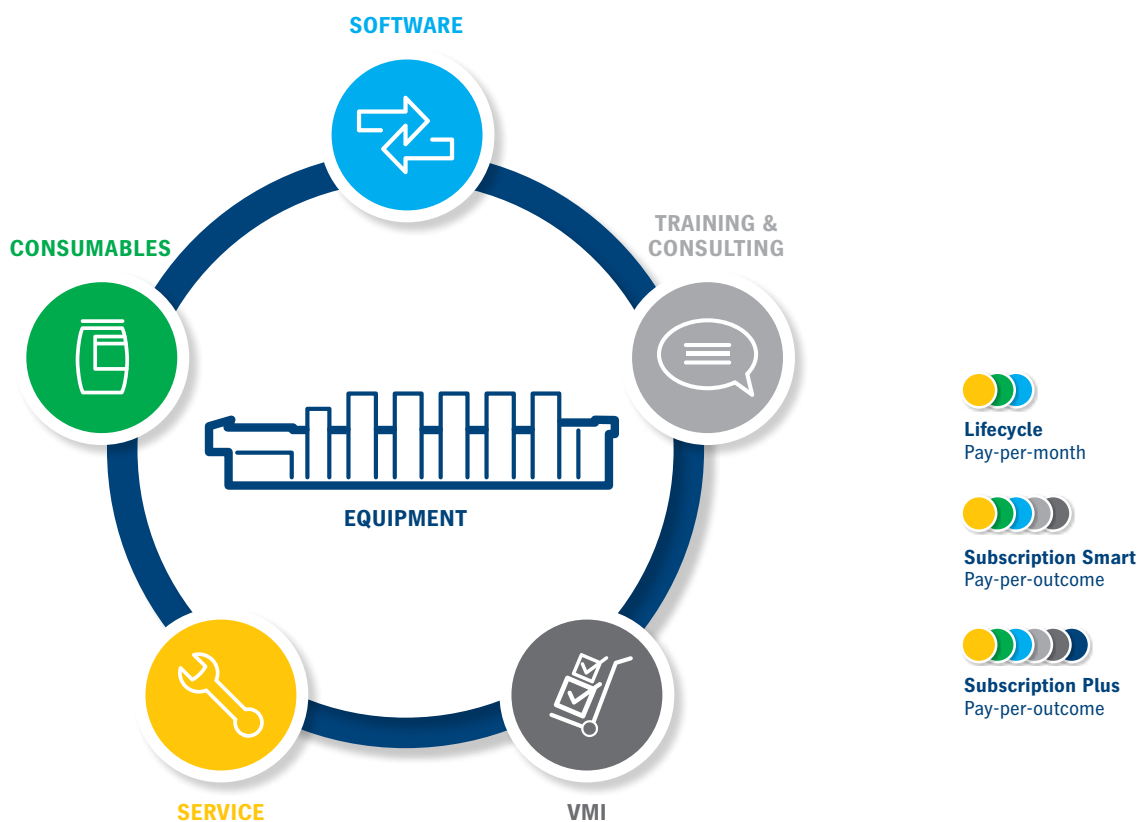

Our contracts are scalable to your needs: We put together a lifecycle contract package for you from at least two of the three components – service, consumables and software. This offers you everything you need for reliable and stable printing production. The services are billed on a monthly basis. Subscription also includes training and consulting, Vendor Managed Inventory (VMI), and optional equipment. VMI automates the management of consumables. Thanks to the strong partnership with HEIDELBERG, you can enjoy the benefits of a comprehensive and optimized print

production system. With Subscription, payment is made per printed sheet.

The following applies to both packages: You reduce your process costs and gain more time for your customers.

**Have we piqued your interest?** Let us work together to create your customized solution package that best fits your needs.

➔ [heidelberg.com/contracts](https://www.heidelberg.com/contracts)



## How can we help you? **Get in touch with us.**

We hope that this brochure will inspire you. There is more we can tell you about how we could make your printing business more efficient and profitable.

If you are interested in the **Versafire LP** or would like to learn more about what we can offer, feel free to **contact us**. We're only ever an e-mail or phone call away.

Reach us by email

→ [contact@heidelberg.com](mailto:contact@heidelberg.com)

Use the contact form

→ [heidelberg.com/info](https://heidelberg.com/info)

Please find the phone numbers of your local sales organization here:

→ [heidelberg.com/contact](https://heidelberg.com/contact)



**Publishing information**

Heidelberger Druckmaschinen AG  
Kurfuersten-Anlage 52 – 60  
69115 Heidelberg  
Germany  
Phone +49 6221 92-00  
Fax +49 6221 92-6999  
contact@heidelberg.com  
Further details at:  
heidelberg.com

**Production note**

Photo credits: Heidelberger Druckmaschinen AG;  
Shutter, Jacob Lund (19)  
Platemaking: Suprasetter  
Printing: Speedmaster  
Finishing: Stahlfolder  
Consumables: Saphira

**Printed in Germany****Trademarks**

HEIDELBERG, the HEIDELBERG logo, Versafire and Prinect are registered trademarks of Heidelberger Druckmaschinen AG in the U.S. and other countries. All other trademarks are property of their respective owners.

For details on the emissions of the Versafire LP, please visit us at [heidelberg.com/emissiondetails](http://heidelberg.com/emissiondetails).

**Liability for contents**

The contents of this brochure have been prepared with great care. No warranty or liability is accepted for the correctness, completeness, or accuracy of the information. There is no guarantee or warranty that the customer will be able to achieve the values and numbers (e. g. relating to the function and performance of the machine and the software) specified in the brochure. The information provided is based on ideal conditions and proper use of the machine and the software. Achieving these values and numbers depends on a variety of factors and circumstances that are outside the control of HEIDELBERG (e. g. machine settings, technical conditions, ambient conditions, raw materials and supplies used, consumables used, standard of care and maintenance of the machine, expertise of the operator, meeting the respective system requirements, etc.).

**Version Sep 2023**